

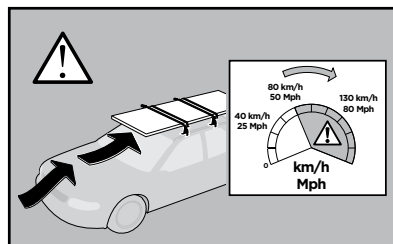

## Thule Rapid System Kit 1746

# > Instructions

TOYOTA Corolla, 4-dr Sedan, 14-

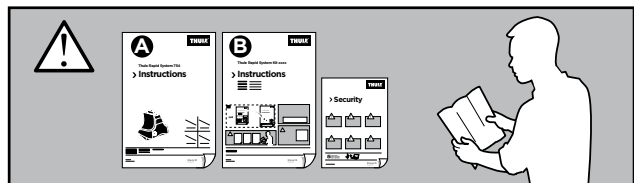
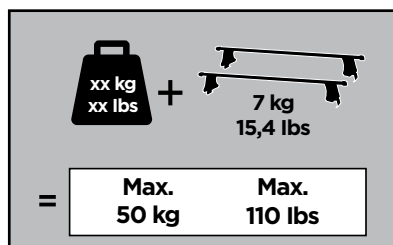
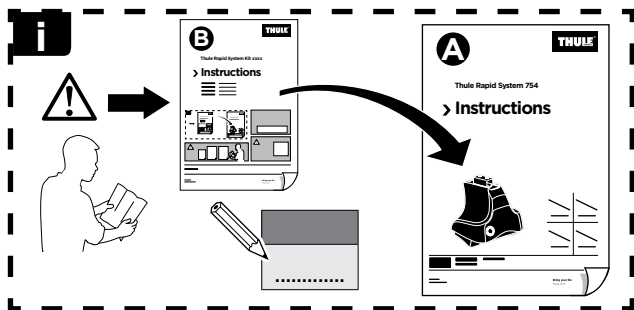

ISO 11154-E

141746

C.20150605  
519-1746-02

Bring your life  
thule.com

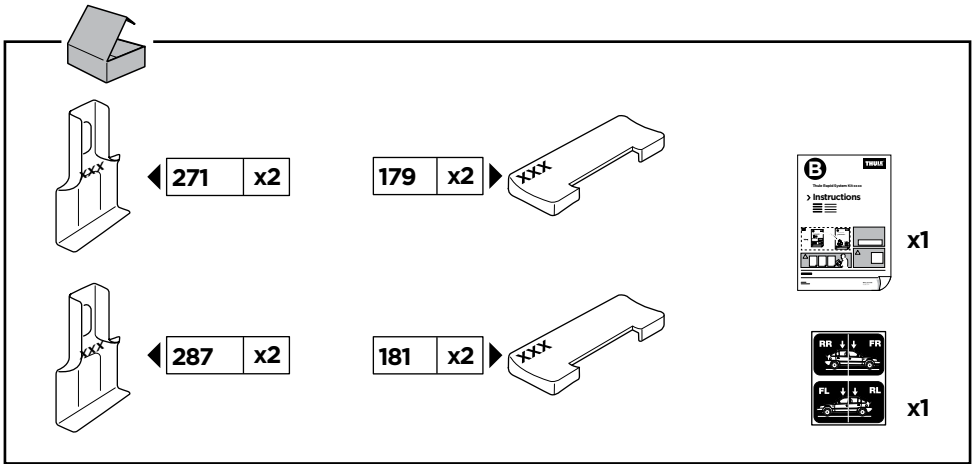

**1**

|  | X (scale)   | X (mm)     | X (inch)                            |
|--|-------------|------------|-------------------------------------|
| <b>TOYOTA Corolla, 4-dr Sedan, 14-</b> | <b>30,5</b> | <b>956</b> | <b>37 <sup>5</sup>/<sub>8</sub></b> |

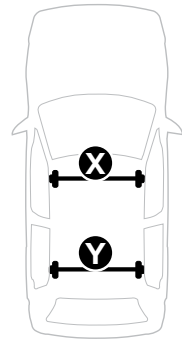
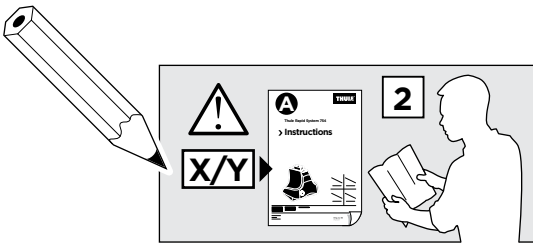

|  | Y (scale)   | Y (mm)     | Y (inch)                            |
|--|-------------|------------|-------------------------------------|
| <b>TOYOTA Corolla, 4-dr Sedan, 14-</b> | <b>27,5</b> | <b>926</b> | <b>36 <sup>1</sup>/<sub>2</sub></b> |

**2**

**TOYOTA Corolla, 4-dr Sedan, 14-**

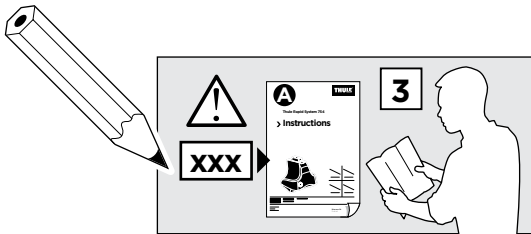
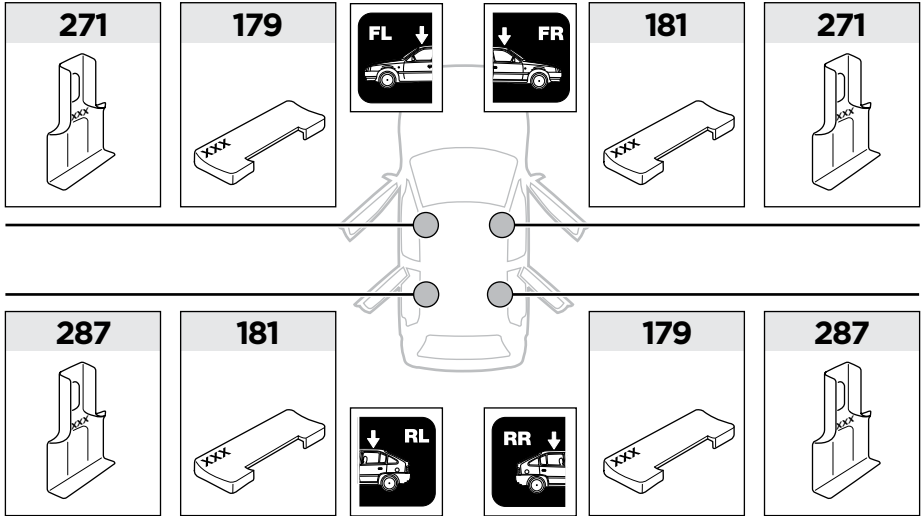

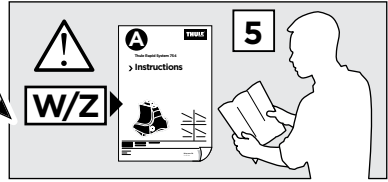
**3**

|  | W (mm)     | Z (mm)     | W (inch)                           | Z (inch)                            |
|--|------------|------------|------------------------------------|-------------------------------------|
| <b>TOYOTA Corolla, 4-dr Sedan, 14-</b> | <b>170</b> | <b>790</b> | <b>6 <sup>3</sup>/<sub>4</sub></b> | <b>31 <sup>1</sup>/<sub>8</sub></b> |

