

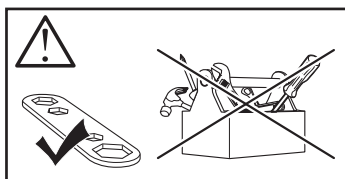

Thule XT Kit 3144

> Instructions

FIAT Fullback, 4-dr Double Cab, 16-
MITSUBISHI L200, 4-dr Double Cab, 15-
MITSUBISHI Triton, 4-dr Double Cab, 15-



This kit is only for vehicles with fixpoint mounting.

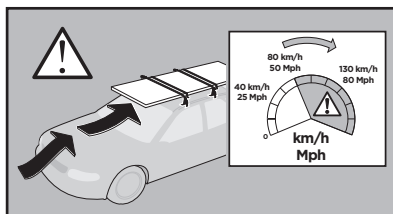
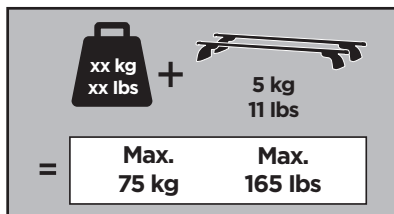
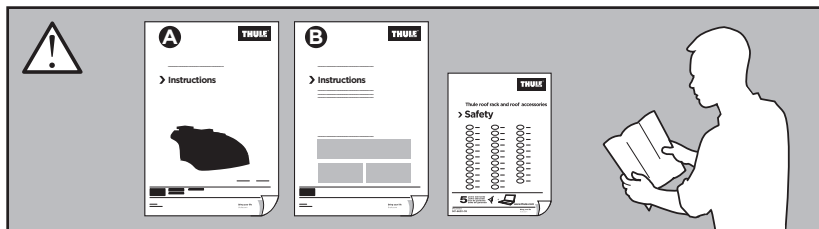

ISO 11154-E

183144

C.20160811
509-3144-02

Bring your life
thule.com

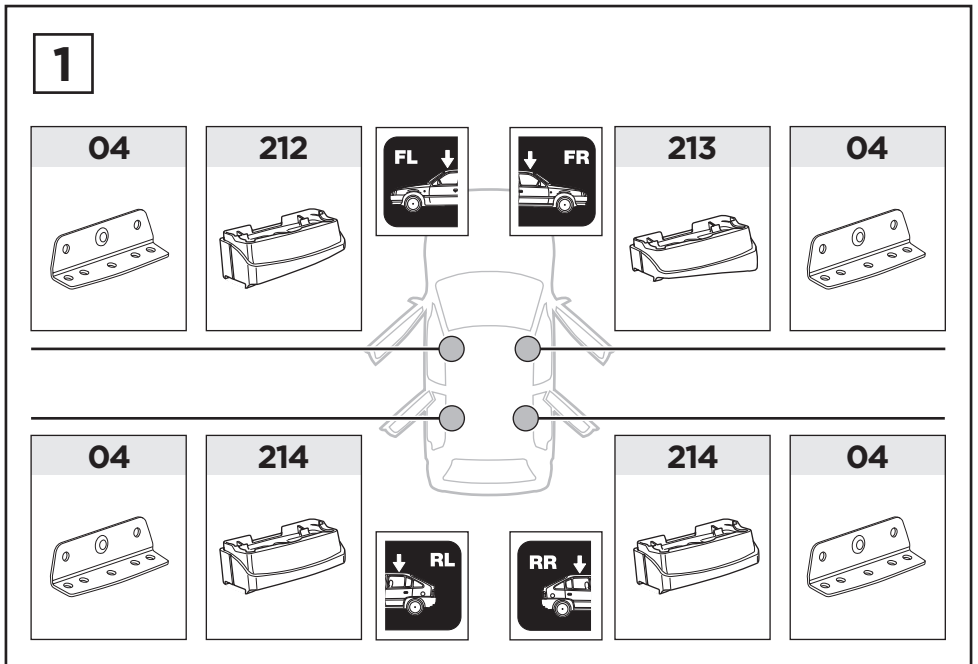
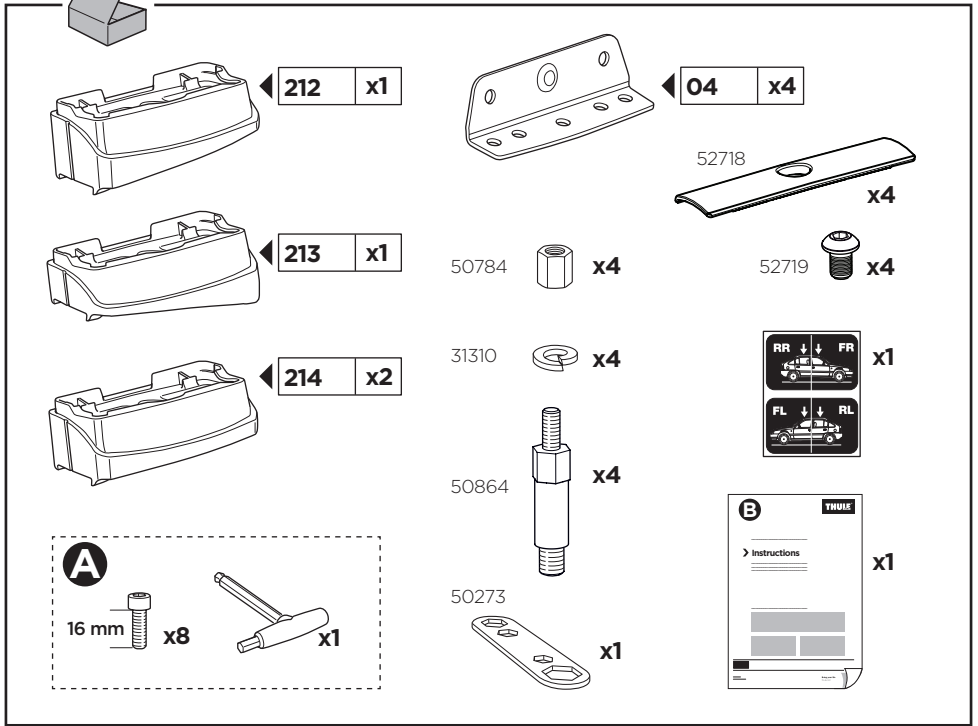

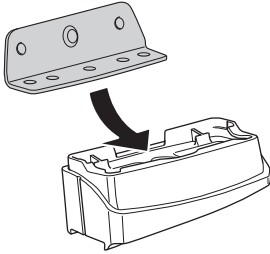
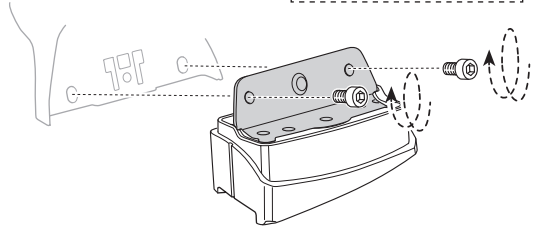
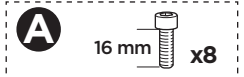
2**A****B**

EN Only a few turns	ET Ainult mõni pööre	RO Doar câteva rotiri
DE Nur wenige Umdrehungen	LV Tikai daži apgriezieni	HU Csak néhány fordítás
FR Quelques tours uniquement	LT Tik keli pasukimai	EL Μόνο λίγες περιστροφές
NL Slechts enkele slagen	PL Wystarczy kilka obrotów	TR Yalnızca birkaç tur
IT Solo qualche giro	RU Только несколько оборотов	AR بعض دورات فقط
ES Sólo algunas vueltas	UK Лише декілька обертів	HE רק מספר סיבובים
PT Apenas algumas voltas	BG Само няколко завъртания	ZH 仅几圈
SV Endast några varv	CS Pouze několik otáček	JA 2～3回転のみ
DK Kun nogle få omgange	SK Len niekoľko otáčok	KO 몇 번만 돌리면 됨
NO Bare noen få omdreininger	SL Le nekaj obratov	TH เพียงสองสามรอบ
FI Vain muutama kierros	HR/BIH Samo nekoliko okreta	

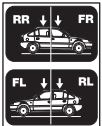
3

x1

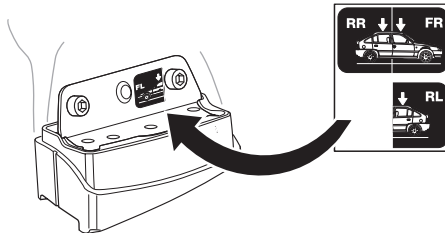

4

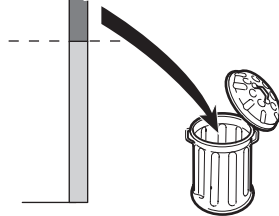
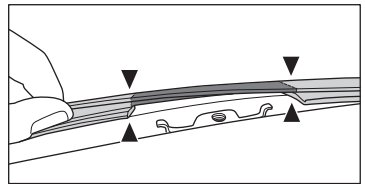
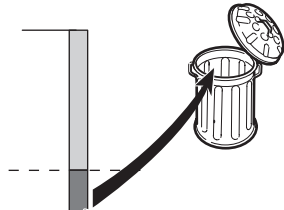
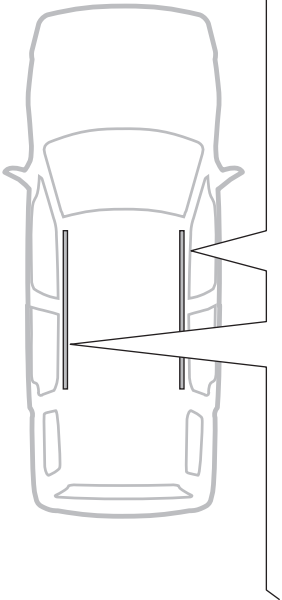
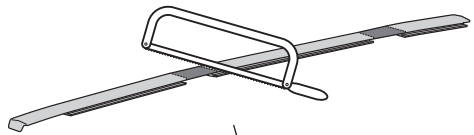
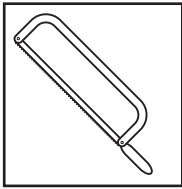
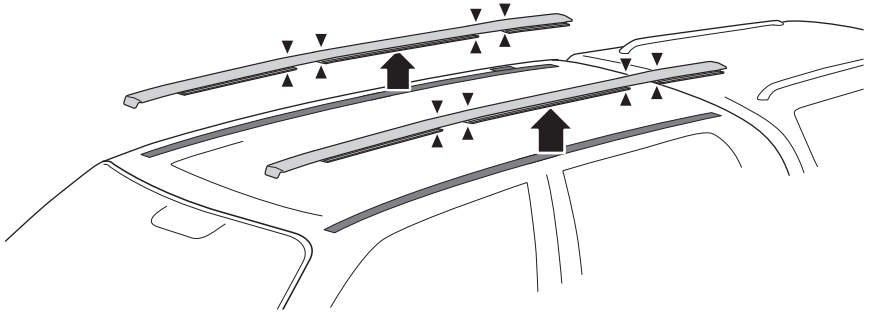

5

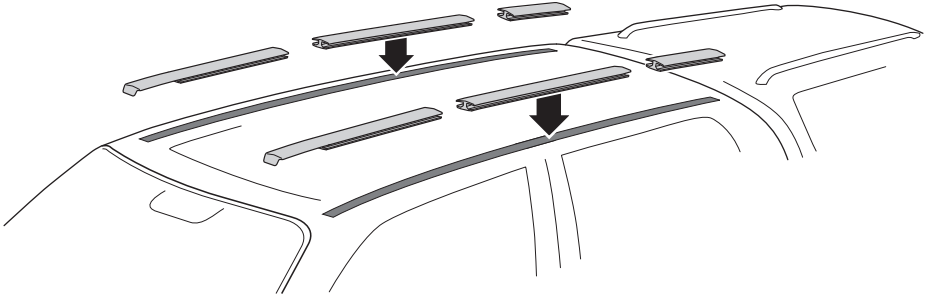

6

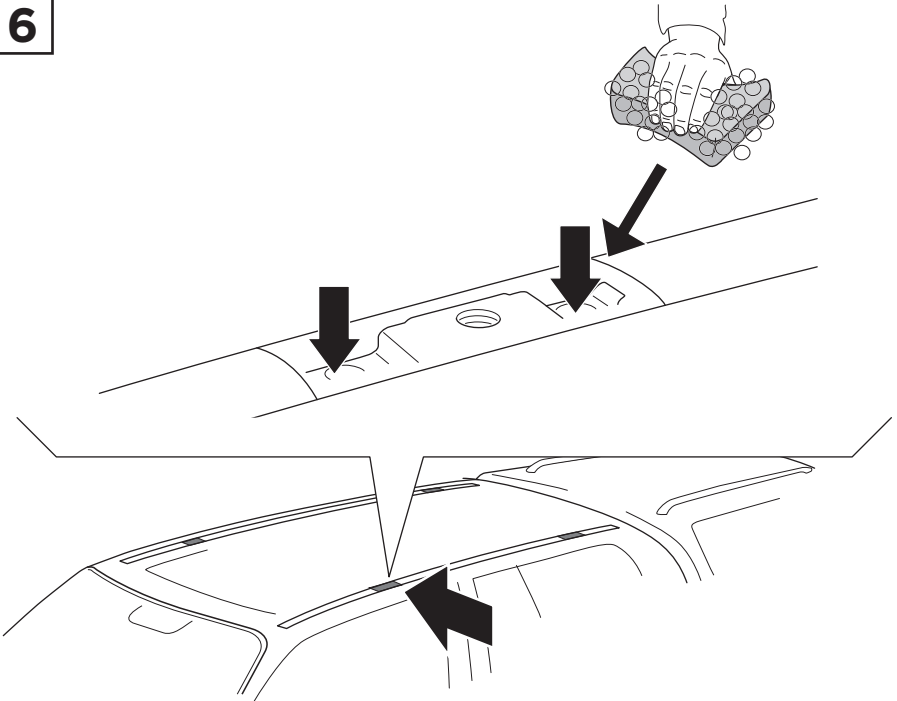

7

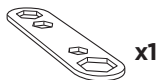

A

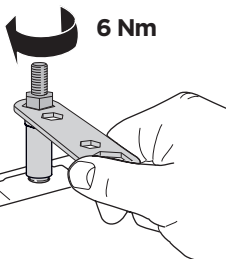
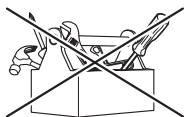
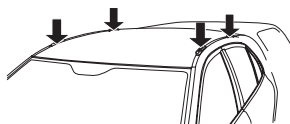

B

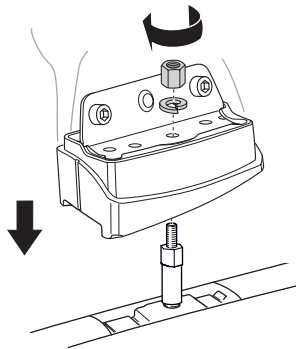

8

A

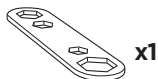
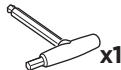

A

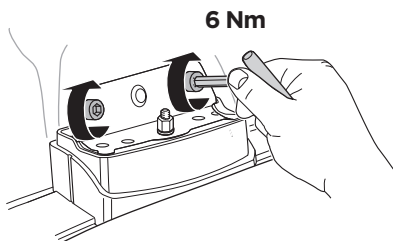

B

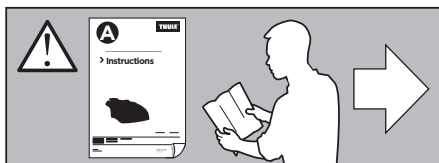
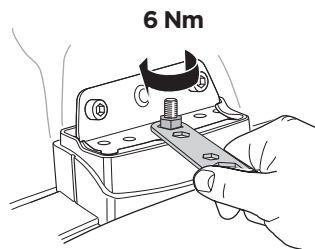

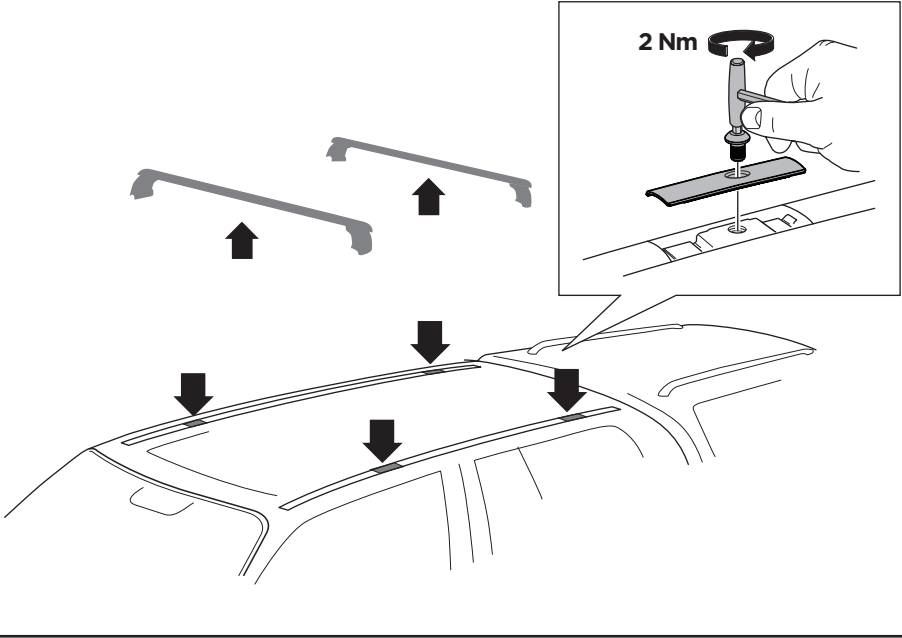
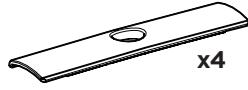
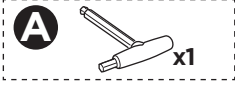



Thule Sweden AB, Box 69, 330 33 Hillerstorp, SWEDEN
Thule Inc., 42 Silvermine Road, Seymour, Connecticut 06483, USA



info@thule.com
Phone: 800-238-2388



www.thule.com