

# Thule Rapid System Kit 1633

# > Instructions

**NISSAN Leaf**, 5-dr Hatchback, 10-17 / \*11-17

\*North America

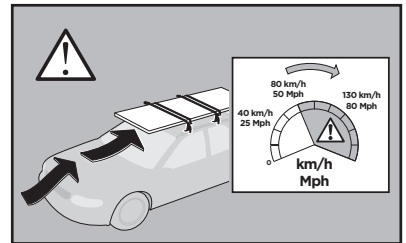
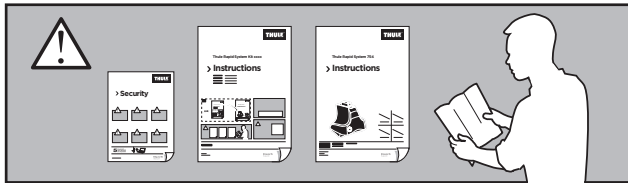
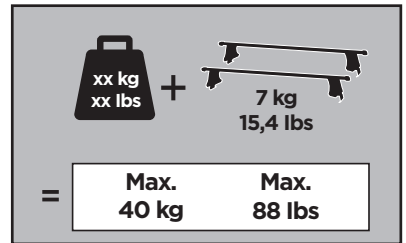
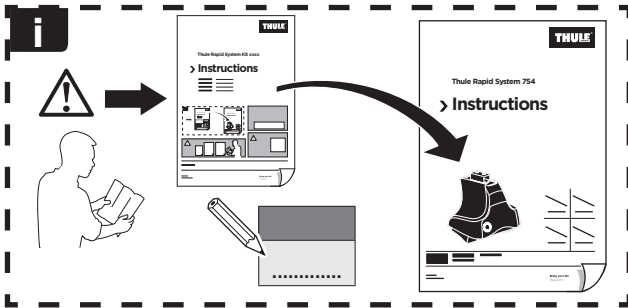

ISO 11154-E



373 x1

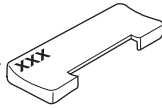

374 x1

375 x1

376 x1



1180 x2



1181 x2



x1



x1

1

	X (scale)	X (mm)	X (inch)
<b>NISSAN Leaf, 5-dr Hatchback, 10-17 / *11-17</b>	<b>41</b>	<b>1061</b>	<b>41 <sup>3</sup>/<sub>4</sub></b>

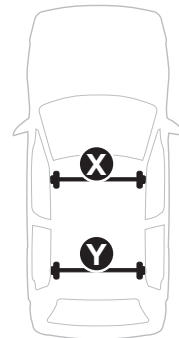
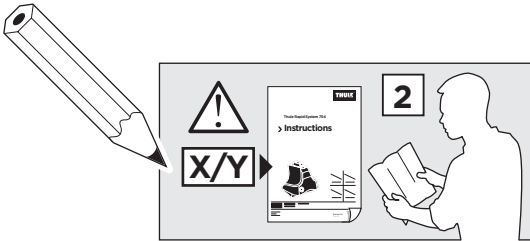

	Y (scale)	Y (mm)	Y (inch)
<b>NISSAN Leaf, 5-dr Hatchback, 10-17 / *11-17</b>	<b>31,5</b>	<b>966</b>	<b>38</b>

2

NISSAN Leaf, 5-dr Hatchback, 10-17 / \*11-17

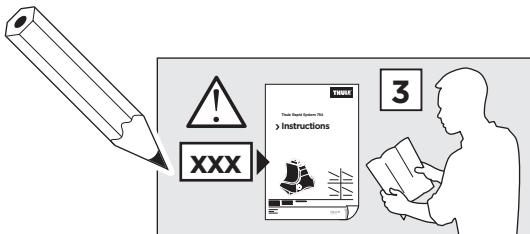
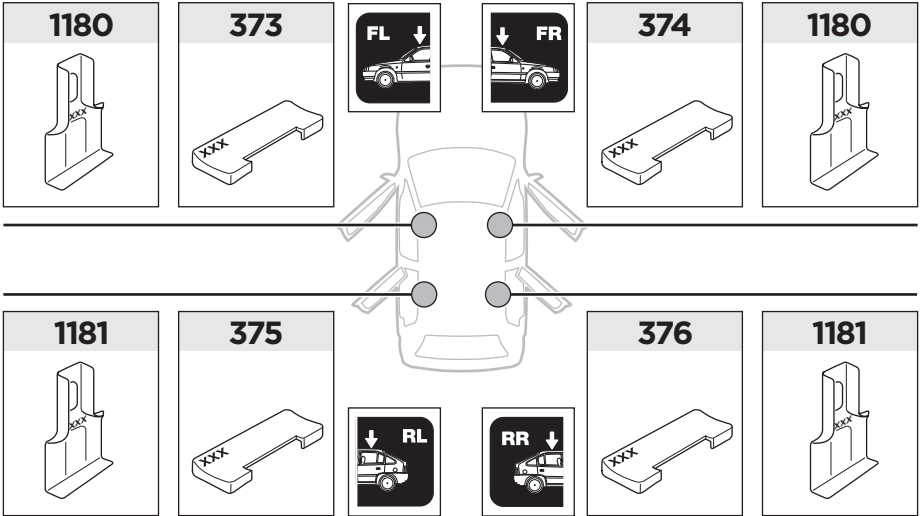

3

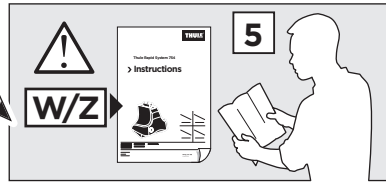
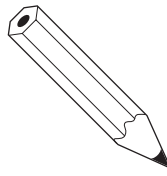

	W (mm)	Z (mm)	W (inch)	Z (inch)
<b>NISSAN Leaf</b> , 5-dr Hatchback, 10-17 / *11-17	<b>280</b>	<b>710</b>	<b>11</b>	<b>28</b>

