



## Thule Rapid System Kit 1688

# > Instructions

**CHEVROLET S10**, 4-dr Double Cab, 12-

**ISUZU D-Max**, 4-dr Crew Cab, 12-

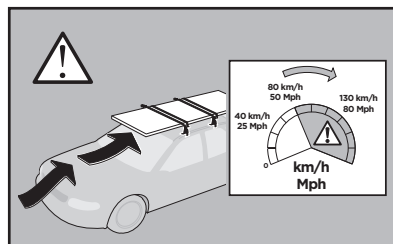
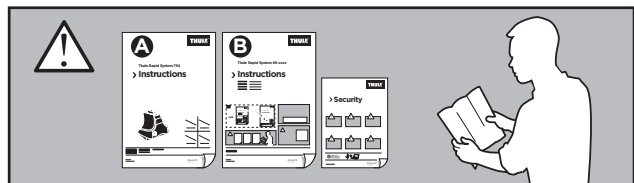
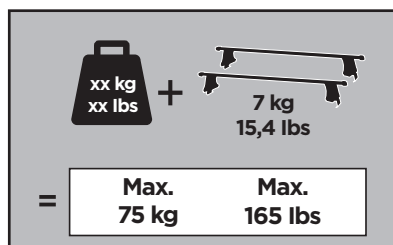
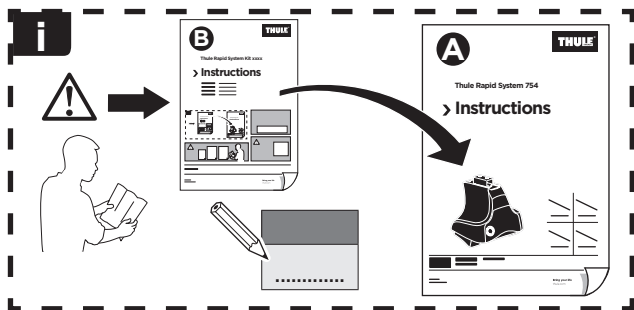

ISO 11154-E

141688

C.20130704  
519-1688-02

Bring your life

thule.com

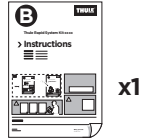
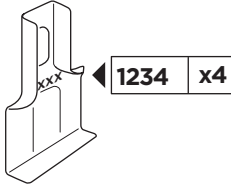
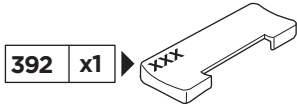
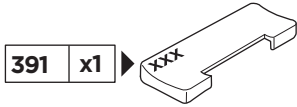
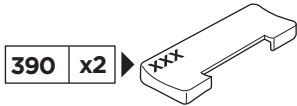

x1

1

	X (scale)	X (mm)	X (inch)
<b>CHEVROLET S10</b> , 4-dr Double Cab, 12-	38	1031	40 <sup>5</sup> / <sub>8</sub>
<b>ISUZU D-Max</b> , 4-dr Crew Cab, 12-	38	1031	40 <sup>5</sup> / <sub>8</sub>

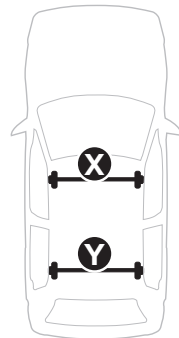
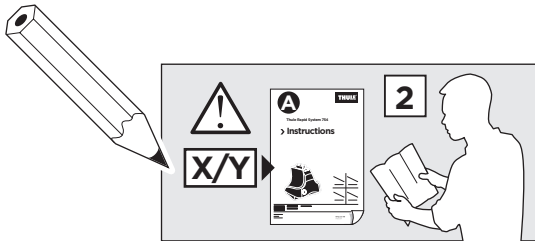

	Y (scale)	Y (mm)	Y (inch)
<b>CHEVROLET S10</b> , 4-dr Double Cab, 12-	35,5	1006	39 <sup>5</sup> / <sub>8</sub>
<b>ISUZU D-Max</b> , 4-dr Crew Cab, 12-	35,5	1006	39 <sup>5</sup> / <sub>8</sub>

**2**

**CHEVROLET S10, 4-dr Double Cab, 12-**  
**ISUZU D-Max, 4-dr Crew Cab, 12-**

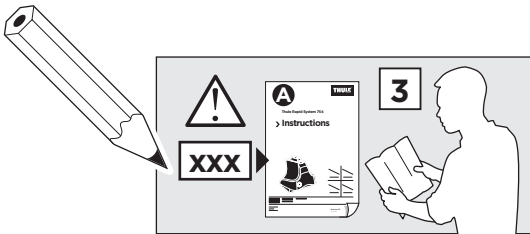
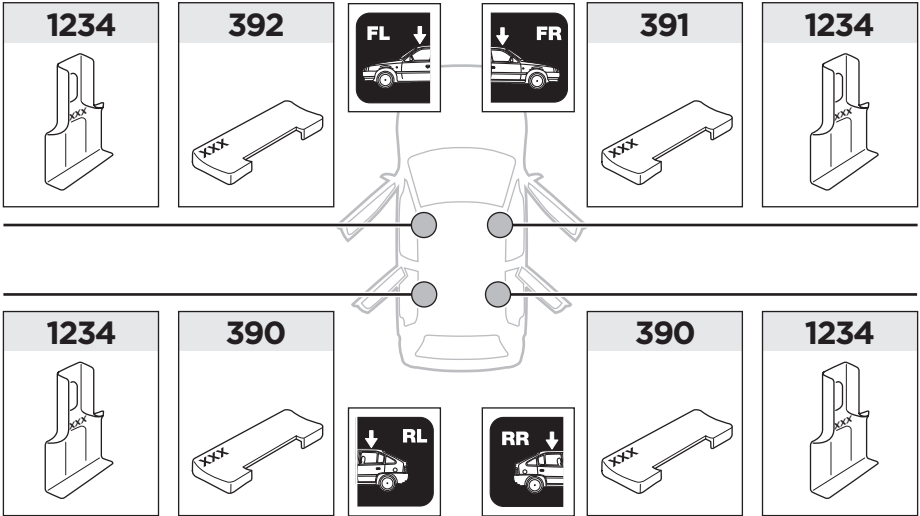

3

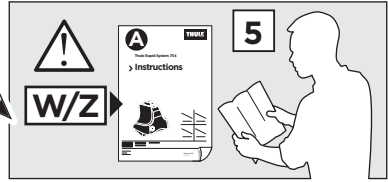
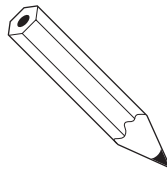

	W (mm)	Z (mm)	W (inch)	Z (inch)
<b>CHEVROLET S10</b> , 4-dr Double Cab, 12-	250	700	9 <sup>7</sup> / <sub>8</sub>	27 <sup>1</sup> / <sub>2</sub>
<b>ISUZU D-Max</b> , 4-dr Crew Cab, 12-	250	700	9 <sup>7</sup> / <sub>8</sub>	27 <sup>1</sup> / <sub>2</sub>

