

# Kit 1580

NISSAN Altima, 4-dr Sedan, \*02-

\*North America

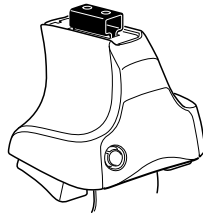

**754** Rapid System  
**480R** Rapid Traverse (North America)

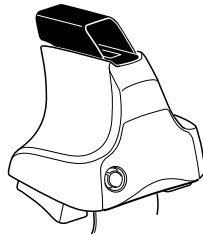
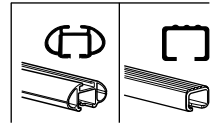

**480** Traverse (North America)

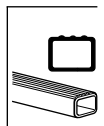

754 Rapid System  
480R Rapid Traverse (North America)

480 Traverse (North America)

1

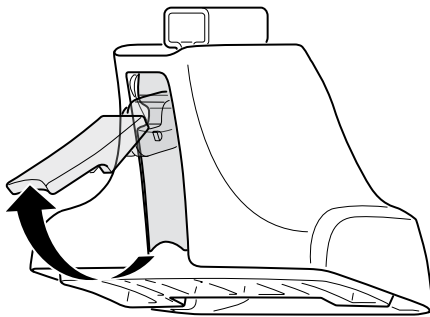

2



754 Rapid System  
480R Rapid Traverse  
(North America)

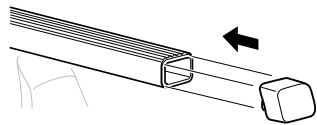
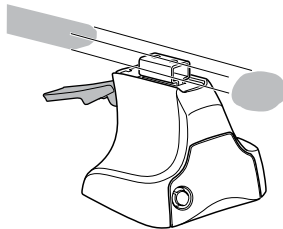

x4

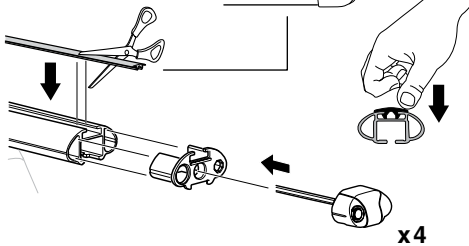
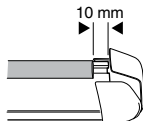
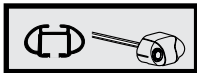

x4

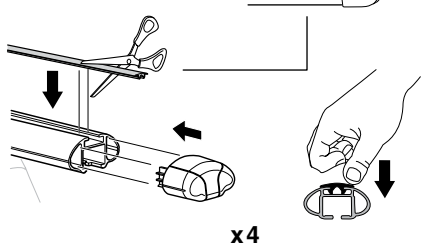
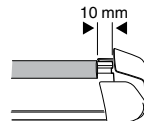
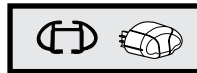

x4



480 Traverse  
(North America)

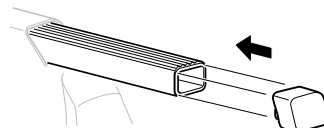
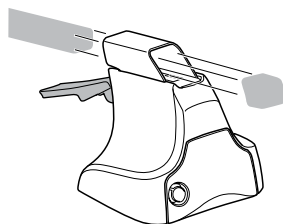

x4

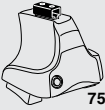
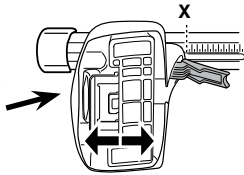
**3****754** Rapid System

	<b>X</b>
<b>NISSAN Altima, 4-dr Sedan, *02-</b>	<b>34</b>

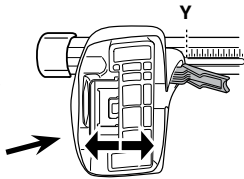

	<b>Y</b>
<b>NISSAN Altima, 4-dr Sedan, *02-</b>	<b>31,5</b>

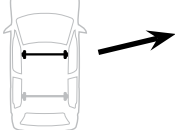
**3****480R** Rapid Traverse**480** Traverse**(North America)**

	<b>X inch</b>	<b>X mm</b>
<b>NISSAN Altima, 4-dr Sedan, *02-</b>	<b>38 <sup>3</sup>/<sub>4</sub>"</b>	<b>984 mm</b>

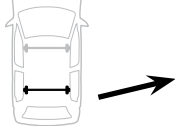

	<b>Y inch</b>	<b>Y mm</b>
<b>NISSAN Altima, 4-dr Sedan, *02-</b>	<b>37 <sup>7</sup>/<sub>8</sub>"</b>	<b>962 mm</b>

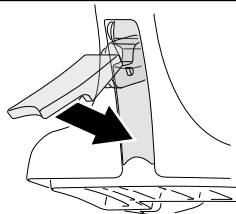
**4**

# 5

NISSAN Altima, 4-dr Sedan, \*02--

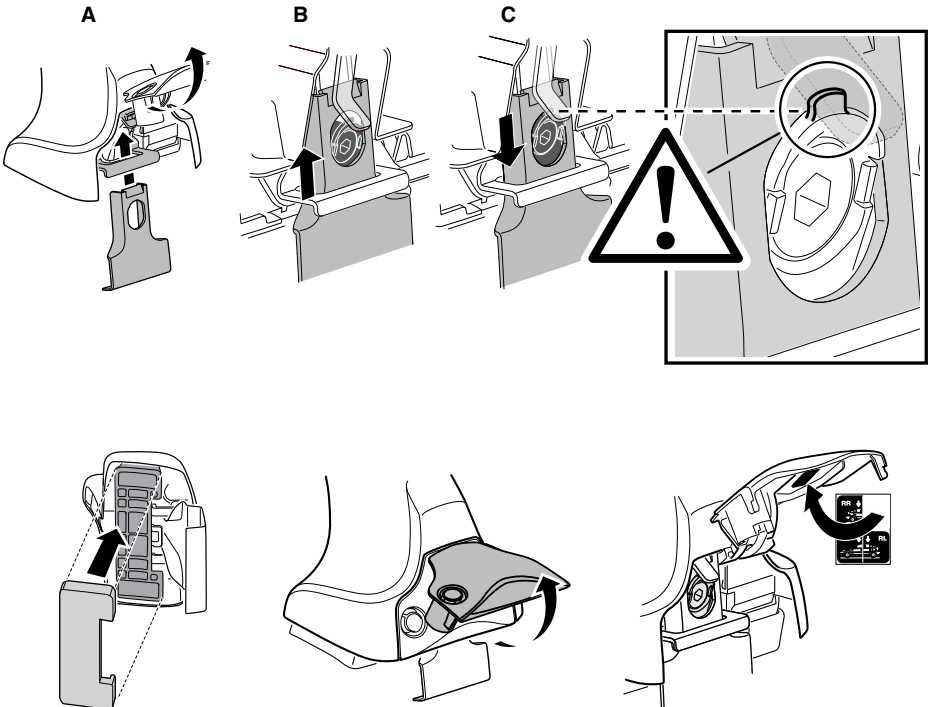
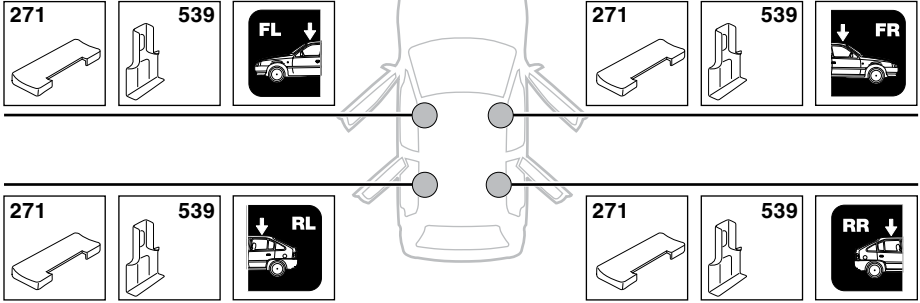

6

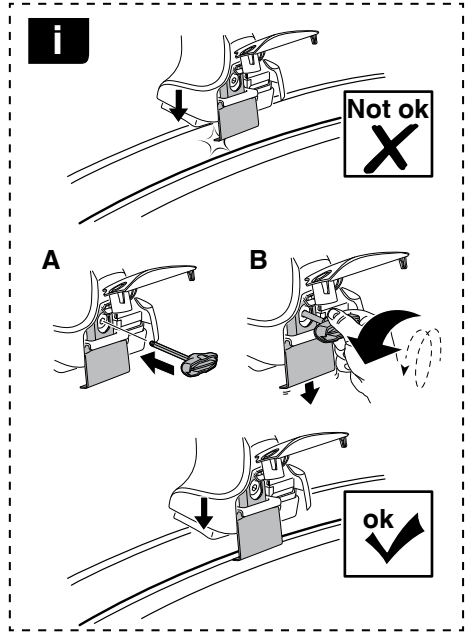
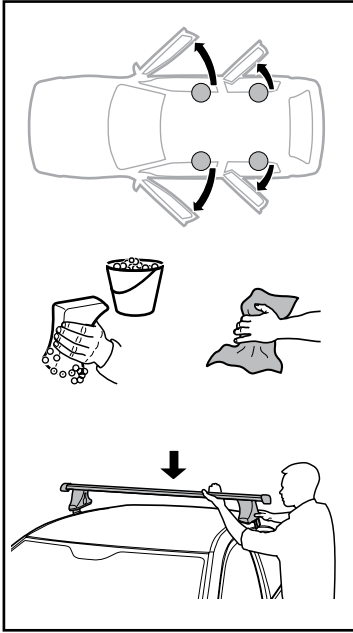

NISSAN Altima, 4-dr Sedan, \*02-

X mm

Y mm

X inch

Y inch

255 mm

710 mm

10"

28"

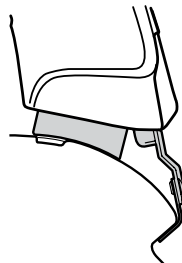
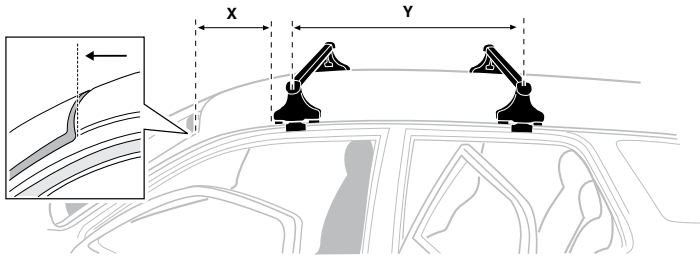

7

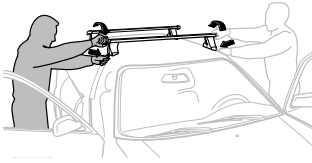

<b>GB/US</b>	Tighten alternately
<b>D</b>	Die Schrauben abwechselnd anziehen
<b>F</b>	Serrer alternativement chaque côté
<b>NL</b>	Afwisselend aan de linker- en de rechterkant aandraaien
<b>I</b>	Alternare il serraggio delle viti
<b>E</b>	Apertar alternativamente
<b>PT</b>	Aperte alternadamente
<b>S</b>	Dra åt växelvis
<b>FIN</b>	Kierrä vuorotellen
<b>EST</b>	Pinguldage vaheldumisi
<b>LAT</b>	Pielveiciet pamišus
<b>LIT</b>	Užsukinėkite pakaitomis
<b>PL</b>	Śruby dokręcaj naprzemiennie
<b>RU</b>	Загряивайте попеременно

<b>CZ</b>	Pokręřta багаžnika dokręcaj naprzemiennie.
<b>SK</b>	Dofahajte striedavo
<b>SLO</b>	Privijajte izmenično.
<b>HR</b>	Naizmjenično zategnite
<b>HU</b>	Egymástól függetlenül szorítandó
<b>GR</b>	Σφιγίγες ενολάξ
<b>TR</b>	Dönüşümlü sıkın

**中文** 交替拧紧

**한국어** 번갈아 가며 조이십시오.

**日本語** 交互に締め付けてください。

**ไทย** ชันในแบบสลับ

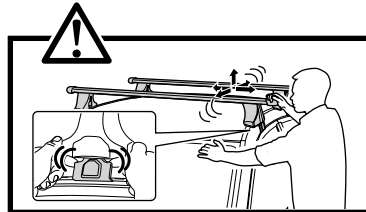
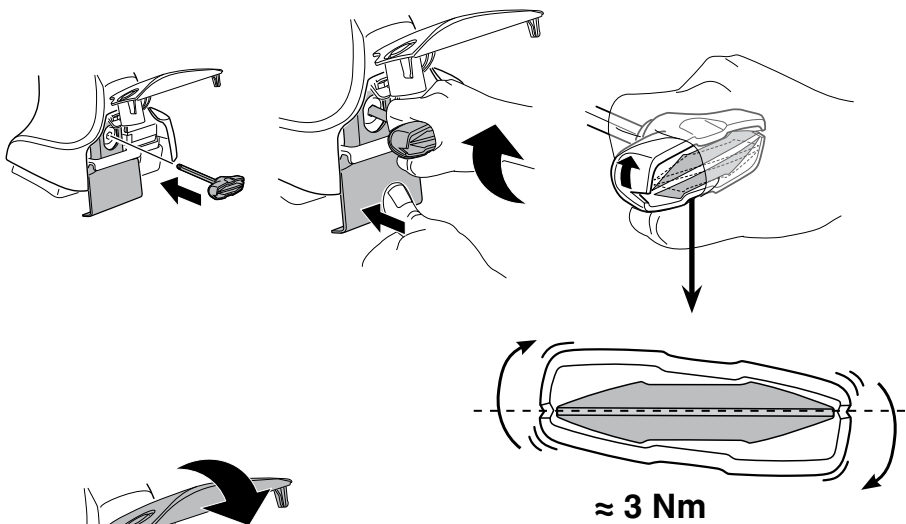

8

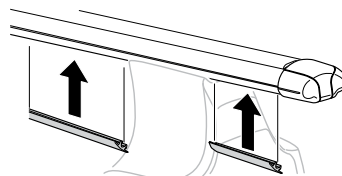
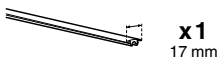

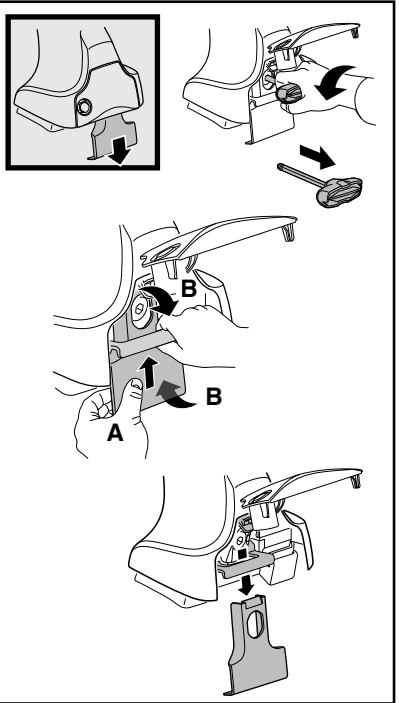
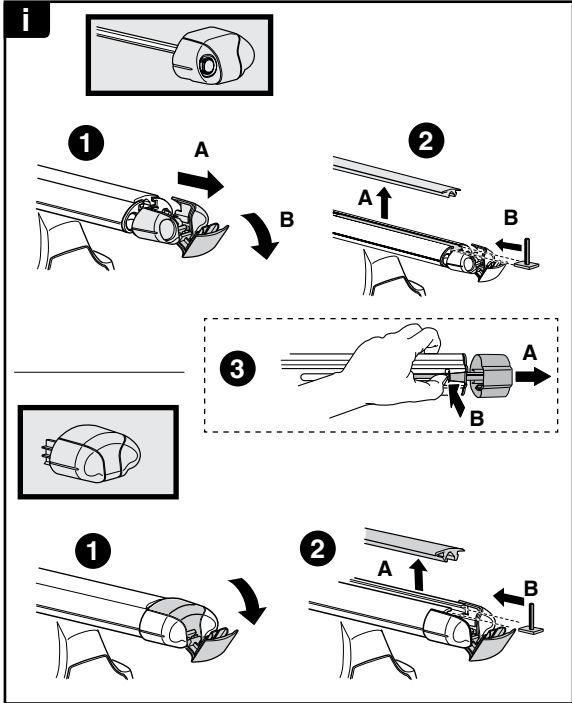
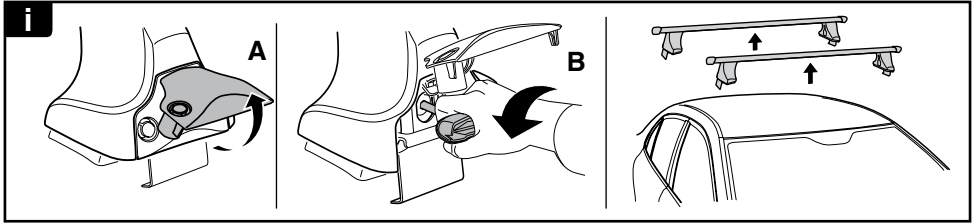

**THULE**  
SWEDEN  
**ONE  
KEY  
SYSTEM**

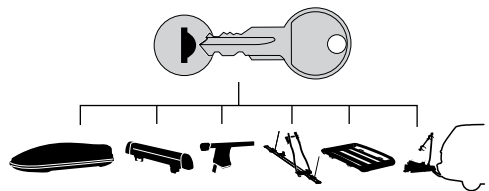

		(x4)
		(x6)
		(x8)
NA		(x10)
EUR		(x12)
ASIA		

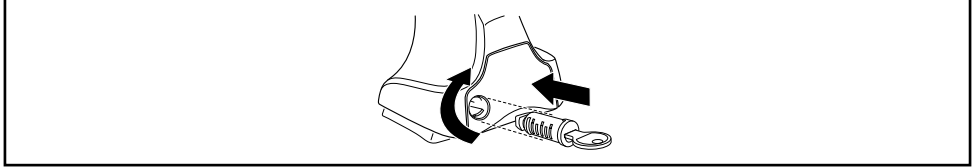

WW ▶ Thule Sweden AB, Box 69, 330 33 Hillerstorp, SWEDEN  
NA ▶ Thule Inc., 42 Silvermine Road, Seymour, Connecticut 06483, USA

info@thule.com  
customer.service@thule.com

www.thule.com