



Thule Rapid System Kit 1790

> Instructions

VOLKSWAGEN Passat CC, 4-dr Coupé, 08-11 / *09-11

VOLKSWAGEN CC, 4-dr Coupé, 12-17

*North America

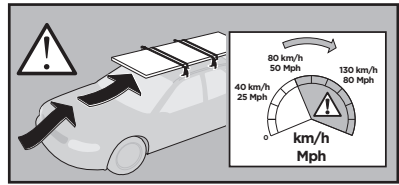
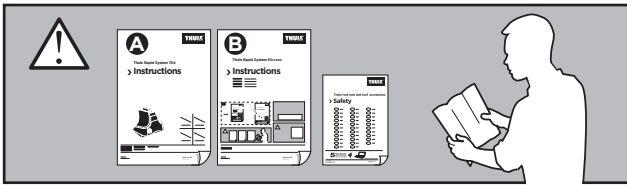
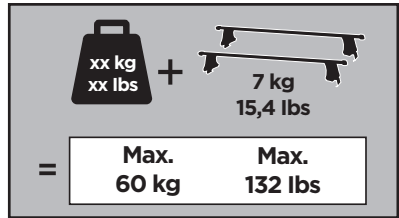
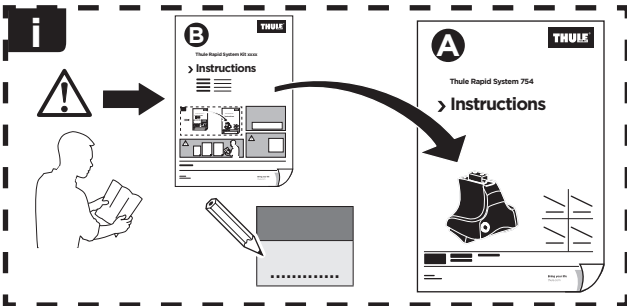
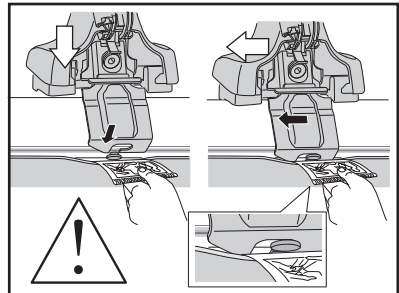
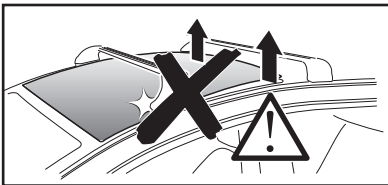

ISO 11154-E

141790

C.20170911
519-1790-03

Bring your life
thule.com

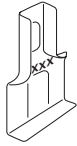

- ◀ 1331 x1
- ◀ 1332 x1
- ◀ 1333 x1
- ◀ 1334 x1

93 x2 ▶

302 x1 ▶

303 x1 ▶

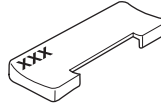

52576



x2

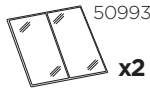

50993

x2



x1



x1

1

	X (scale)	X (mm)	X (inch)
VOLKSWAGEN Passat CC , 4-dr Coupé, 08-11 / *09-11	42	1071	42 ¹ / ₈
VOLKSWAGEN CC , 4-dr Coupé, 12-17	42	1071	42 ¹ / ₈

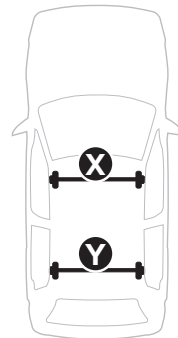
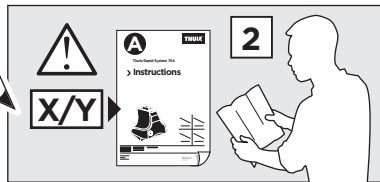
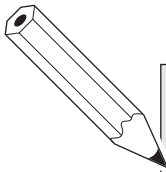

	Y (scale)	Y (mm)	Y (inch)
VOLKSWAGEN Passat CC , 4-dr Coupé, 08-11 / *09-11	40	1051	41 ³ / ₈
VOLKSWAGEN CC , 4-dr Coupé, 12-17	40	1051	41 ³ / ₈

2

VOLKSWAGEN Passat CC, 4-dr Coupé, 08-11 / *09-11

VOLKSWAGEN CC, 4-dr Coupé, 12-17

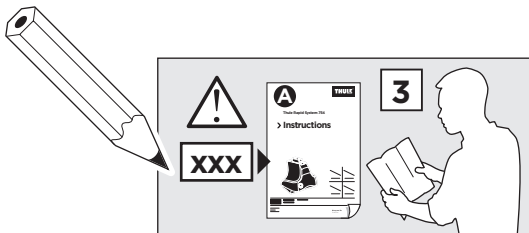
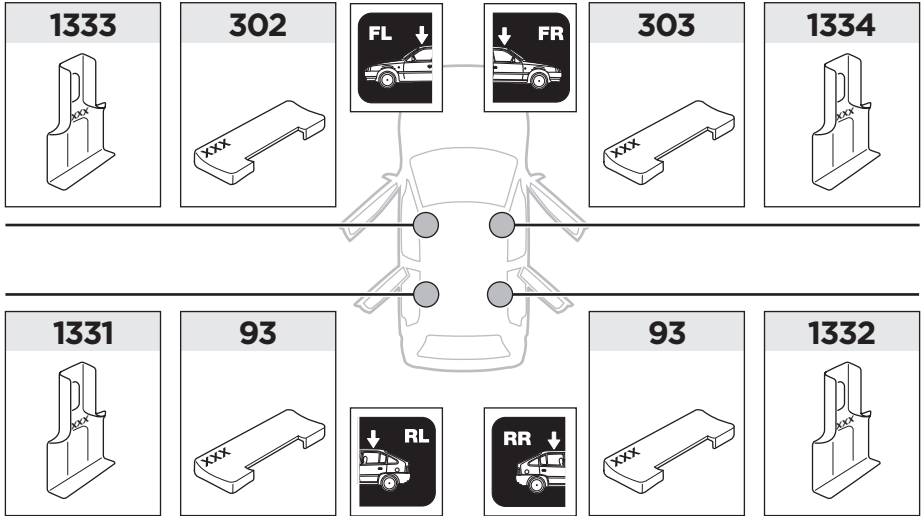

3

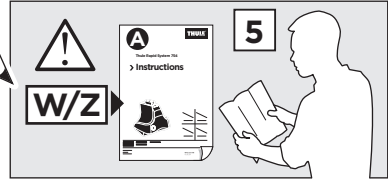

	W (mm)	Z (mm)	W (inch)	Z (inch)
VOLKSWAGEN Passat CC , 4-dr Coupé, 08-11 / *09-11	155	735	6 1/8	28 7/8
VOLKSWAGEN CC , 4-dr Coupé, 12-17	155	735	6 1/8	28 7/8

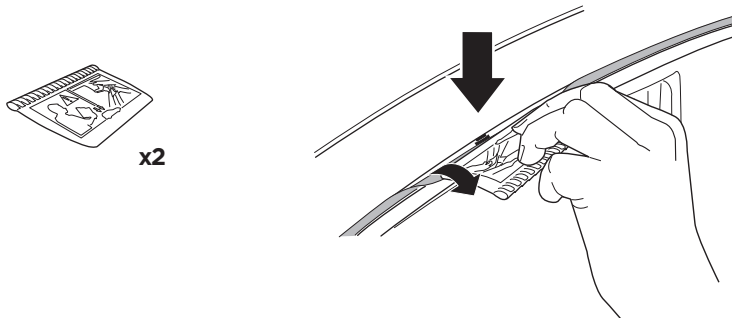
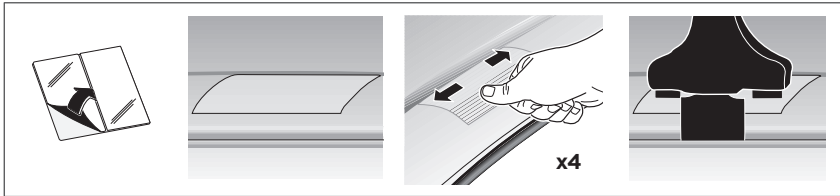
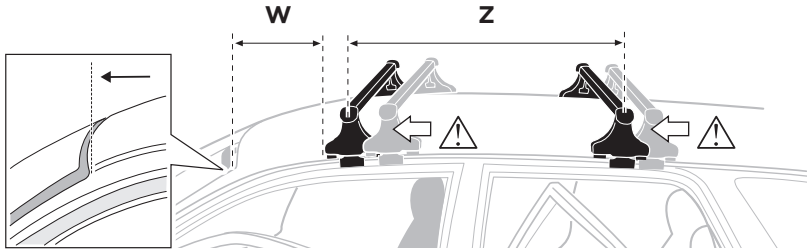

4

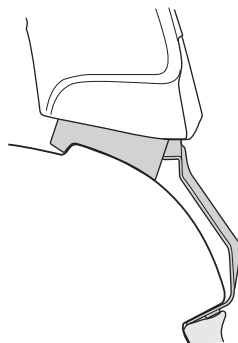
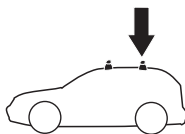
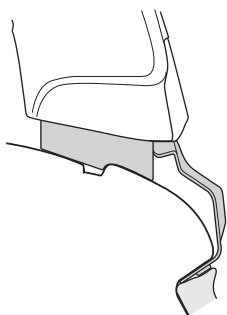
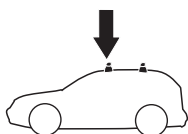
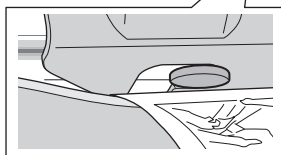
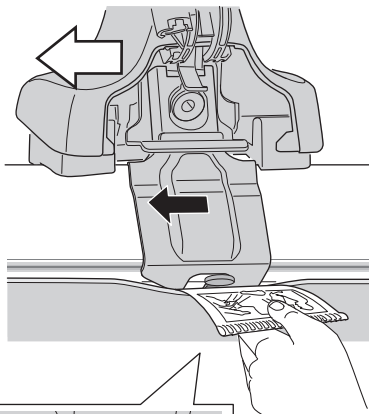
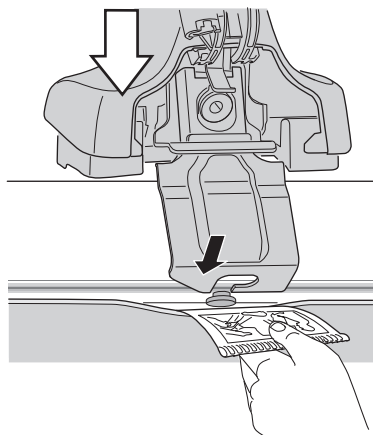



Thule Sweden AB, Box 69, 330 33 Hillerstorp, SWEDEN
Thule Inc., 42 Silvermine Road, Seymour, Connecticut 06483, USA



info@thule.com
Phone: 800-238-2388



www.thule.com