

Thule Rapid System Kit 1619

> Instructions

NISSAN Juke, 5-dr SUV, 10-

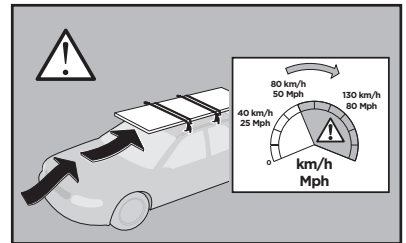
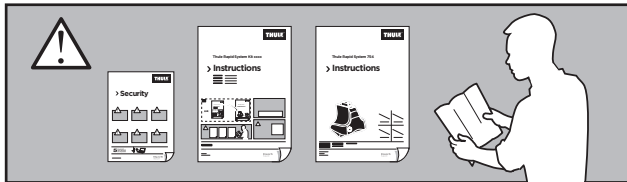
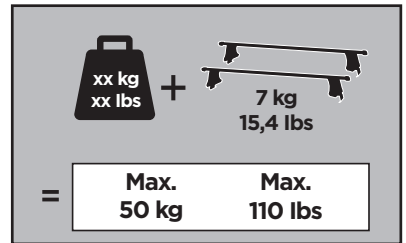
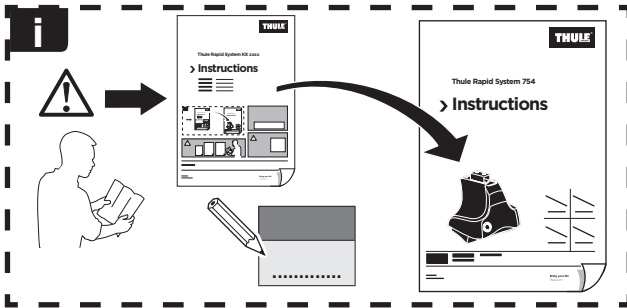
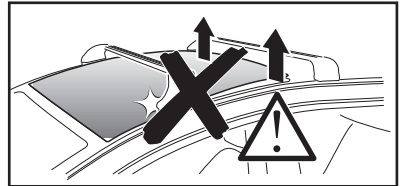

ISO 11154-E

141619

C.20160929
519-1619-02

Bring your life
thule.com



180 x2

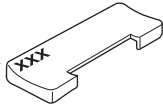

350 x2

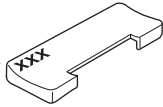

1126 x2



1127 x2



x1

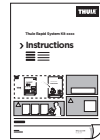

x1

1

	X (scale)	X (mm)	X (inch)
NISSAN Juke, 5-dr SUV, 10-	32.5	976	38 ⁵ / ₈

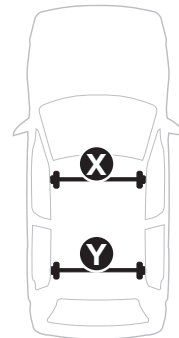
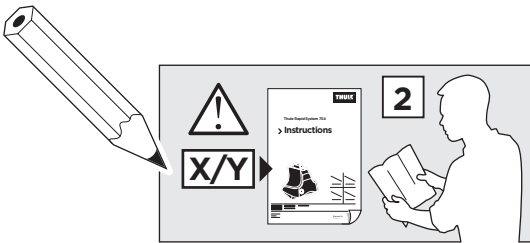

	Y (scale)	Y (mm)	Y (inch)
NISSAN Juke, 5-dr SUV, 10-	30.5	956	37 ⁵ / ₈

2

NISSAN Juke, 5-dr SUV, 10-

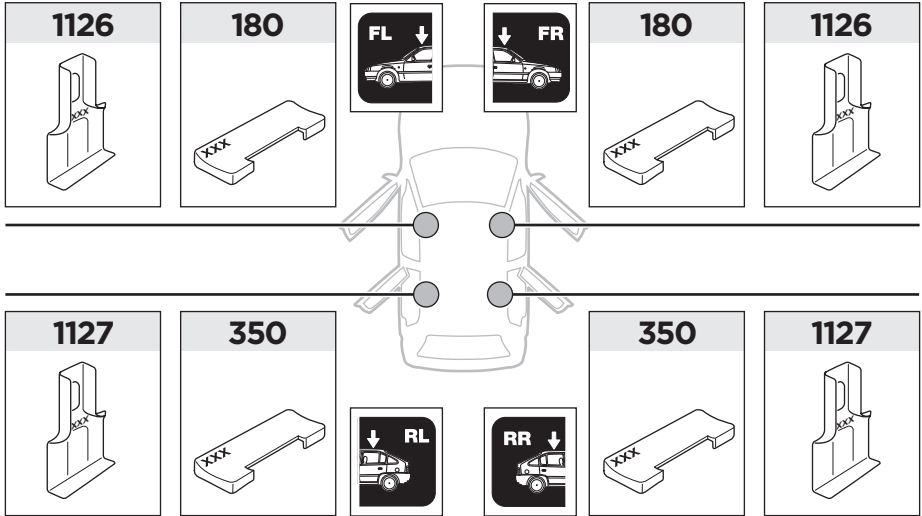

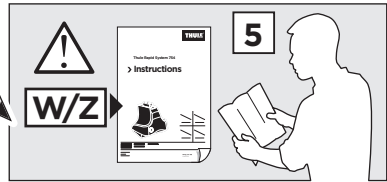
3

	W (mm)	Z (mm)	W (inch)	Z (inch)
NISSAN Juke , 5-dr SUV, 10-	330	650	13	25 ⁵/₈

